



Ku

Performance criteria	
Model	24/28
Steel sheet insert	3 mm
Two-piece with 2 caps	
Invisible fixing	
Washers (available as accessories)	3 mm
<input checked="" type="checkbox"/> Yes - No <input type="checkbox"/> On request	

Product description
Nylon hinge 24 / 28, rising

■ For rising flush doors

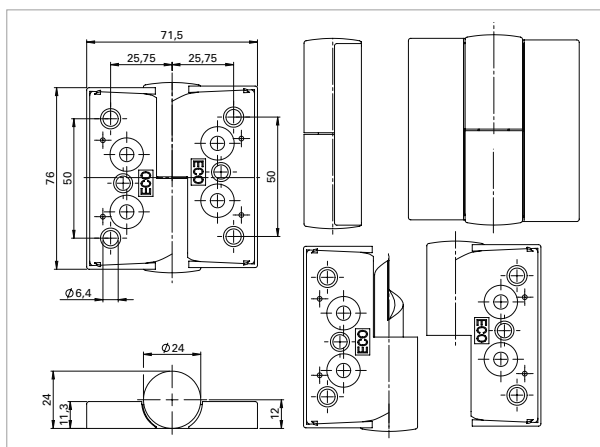

White*
RAL 9010
 Dark grey*
RAL 7030/7038

Ku













Nylon hinge 24 / 28, rising	Colour/material	Art. no.
24 / 28, rising DIN-L	White RAL 9010	5030010378
24 / 28, rising DIN-L	Dark grey RAL 7030/7038	5030010385
24 / 28, rising DIN-R	White RAL 9010	5030010393
24 / 28, rising DIN-R	Dark grey RAL 7030/7038	5030010424

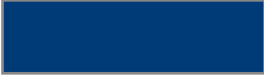

Washer, left clip-on	Colour/material	Art. no.
3 mm DIN-L	White RAL 9010	5030017409
3 mm DIN-L	Dark grey RAL 7030/7038	5030017412

Washer, right clip-on	Colour/material	Art. no.
3 mm DIN-R	White RAL 9010	5030017403
3 mm DIN-R	Dark grey RAL 7030/7038	5030017406

Sanitary partitions ■ Choice of colours

RAL tone similar*	Standard	No.	Colour
RAL 9010		08	White
RAL 7030 / 7038		37	Dark grey
On request			
RAL 3003		01	Red
RAL 9005		02	Black
RAL 8022		04	Dark brown
RAL 6029		05	Green
RAL 1021		07	Yellow
RAL 5002		09	Blue
RAL 9016		15	Traffic white
RAL 3007		18	Dark red
RAL 6012		19	Dark green
RAL 7043		20	Traffic grey
RAL 5011 / 5013		21	Dark blue



ECO Schulte GmbH & Co. KG

Iserlohner Landstraße 89

D-58706 Menden

Telephone +49 2373 9276 - 0

Telefax +49 2373 9276 - 40

info@eco-schulte.de

www.eco-schulte.de

Our compendium represents a compilation of all products from our range of services. These are subject to different delivery classes. Special variants included are often manufactured to customer specifications and sometimes require longer delivery times and minimum purchase quantities. Further advise can be given by your contact person.

■ SYSTEM TECHNOLOGY FOR THE DOOR

