

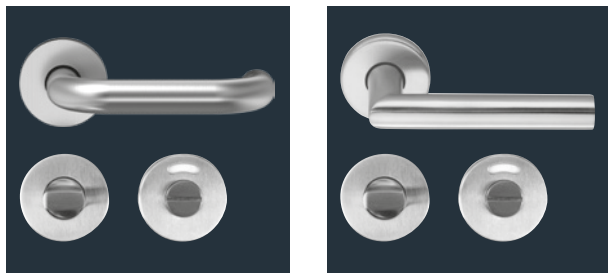

Performance criteria		
Use category		-
Lever handle diameter	19 mm	■
Steel substructure		■
Fixed swivel-mounted lever handle		■
Square spindle	7 mm	□
	8 mm	■
	8.5 mm	□
Concealed, continuous screw attachment		■
■ Yes - No □ On request		

Product description

- Available for all common panel and door thicknesses
- Complete with WC escutcheon and red/white indicator
- Compatible drilling template available
- Square spindle inset in handle

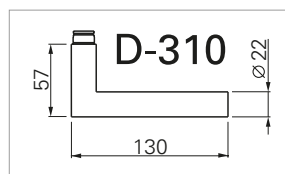
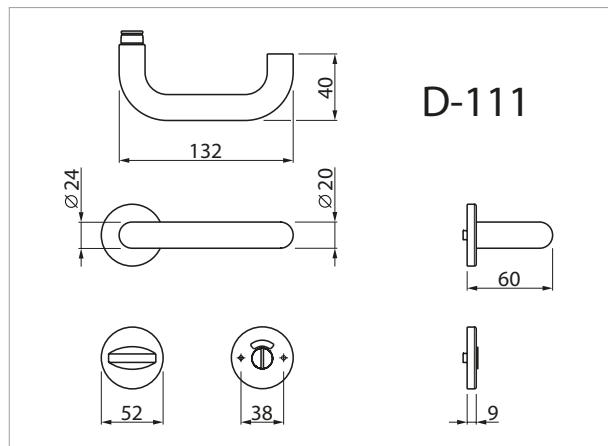

BGL ER

	Colour/material			Door thickness	Model	Art. no.
D-111.ER.10.WC	Stainless steel, matt brushed	21 mm	8 mm	25-30 mm	SK	5030016070
D-310.ER.10.WC	Stainless steel, matt brushed	22 mm	8 mm	25-30 mm	SK	5030020653



Performance criteria

Use category class 3	EN 1906	■
Maintenance-free lever handle guidance		■
Lever handle diameter	21 mm	■
Nylon substructure with positioning studs		■
Fixed swivel-mounted lever handle		■
Square spindle	7 mm	-
	8 mm	■
	8.5 mm	-
Concealed, continuous screw attachment		■

■ Yes - No □ On request

Product description

- Available for all common panel and door thicknesses
- Complete with WC escutcheon and red/white indicator
- Emergency opening via 8 mm square spindle
- External release slot on request
- Also available in BB, PZ and knob/lever models
- Compatible drilling template available, (art. no.: 5030026022)
- Fixed swivel-mounted lever handle with return spring
- Finish: Stainless steel, matt satin finish

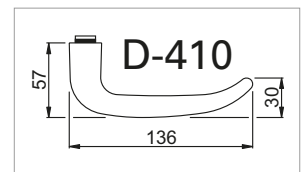
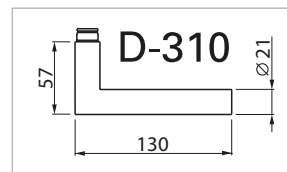
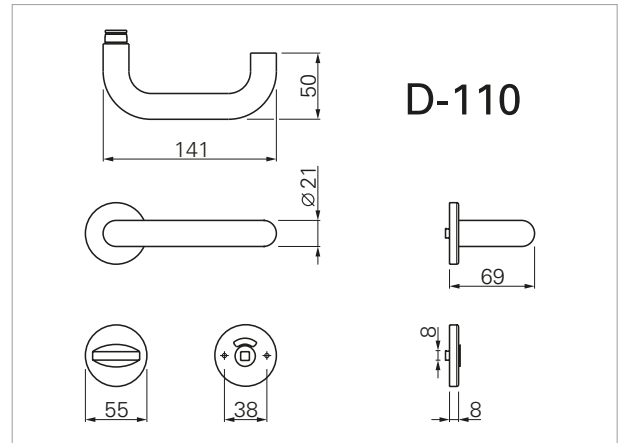

	Colour/material			Door thickness	Model	Art. no.
D-110.ER.12.WC	Stainless steel, matt brushed	21 mm	8 mm	27-31 mm	AV	5030041284
D-310.ER.12.WC	Stainless steel, matt brushed	21 mm	8 mm	27-31 mm	AV	5030041290
D-410.ER.12.WC	Stainless steel, matt brushed	21 mm	8 mm	27-31 mm	AV	5030041293



Performance criteria		
Use category class 4	EN 1906	■
Maintenance-free lever handle guidance		■
Lever handle diameter	21 mm	■
Steel substructure with positioning studs		■
Fixed swivel-mounted lever handle		■
Square spindle	7 mm	-
	8 mm	■
	8.5 mm	-
Concealed, continuous screw attachment		■
■ Yes - No □ On request		





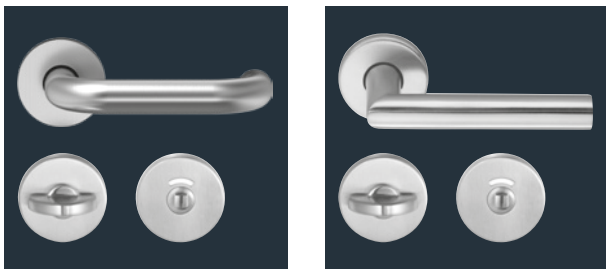
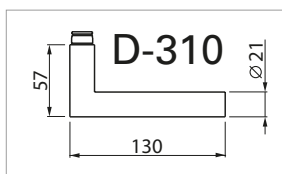
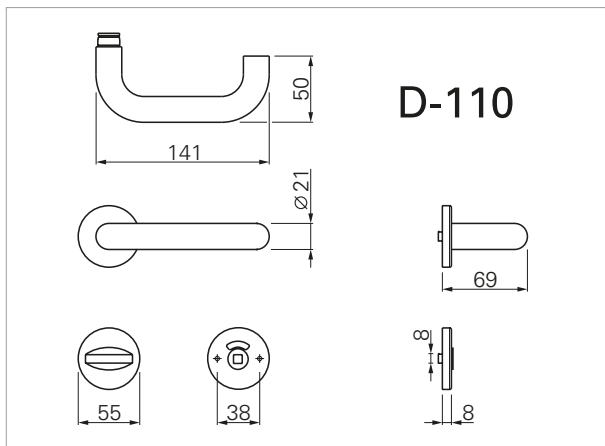







Product description

- Available for all common panel and door thicknesses
- Complete with WC escutcheon and red/white indicator
- Emergency opening via 8 mm square spindle
- External release slot on request
- Also available in BB, PZ and knob/lever models
- Compatible drilling template available
- Fixed swivel-mounted lever handle with return spring
- Finish: Stainless steel, matt satin finish

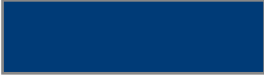

	Colour/material			Door thickness	Model	Art. no.
D-110.ER.13.WC	Stainless steel, matt brushed	21 mm	8 mm	27-31mm	AV	5030042591
D-310.ER.13.WC	Stainless steel, matt brushed	21 mm	8 mm	27-31mm	AV	5030005508

Sanitary partitions ■ Choice of colours

RAL tone similar*	Standard	No.	Colour
RAL 9010		08	White
RAL 7030 / 7038		37	Dark grey
On request			
RAL 3003		01	Red
RAL 9005		02	Black
RAL 8022		04	Dark brown
RAL 6029		05	Green
RAL 1021		07	Yellow
RAL 5002		09	Blue
RAL 9016		15	Traffic white
RAL 3007		18	Dark red
RAL 6012		19	Dark green
RAL 7043		20	Traffic grey
RAL 5011 / 5013		21	Dark blue



ECO Schulte GmbH & Co. KG

Iserlohner Landstraße 89

D-58706 Menden

Telephone +49 2373 9276 - 0

Telefax +49 2373 9276 - 40

info@eco-schulte.de

www.eco-schulte.de

Our compendium represents a compilation of all products from our range of services. These are subject to different delivery classes. Special variants included are often manufactured to customer specifications and sometimes require longer delivery times and minimum purchase quantities. Further advise can be given by your contact person.

■ SYSTEM TECHNOLOGY FOR THE DOOR

