



Leistungskriterien

Ausführung	24/28	■
Einlage Stahlblech	3 mm	■
Zweiteilig mit 2 Kappen		■
Unsichtbare Befestigung		■
Unterlegscheiben (als Zubehör erhältlich)	3 mm	■

■ Ja - Nein □ auf Anfrage

Produktbeschreibung

Kunststofffederband 24 / 28

■ für ungefälzte Türen

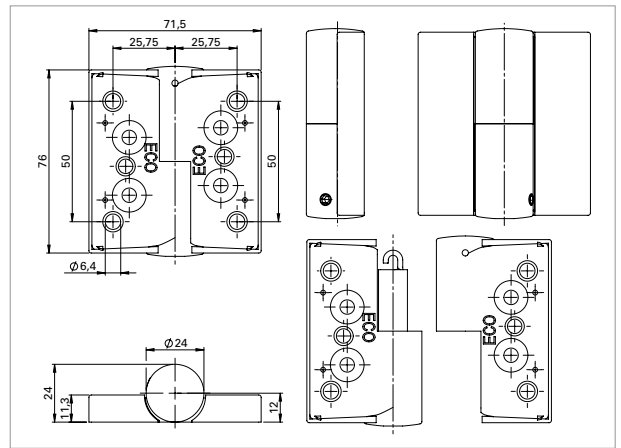

Weiß*
 RAL 9010

Dunkelgrau*
 RAL 7030/7038

Ku

Kunststofffederband 24 / 28	Farbe/Material	Art.-Nr.
24 / 28 DIN-L	Weiß RAL 9010	5030010189
24 / 28 DIN-L	Dunkelgrau RAL 7030/7038	5030011102
24 / 28 DIN-R	Weiß RAL 9010	5030010243
24 / 28 DIN-R	Schwarz RAL 9005	5030010219













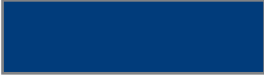

Unterlegscheibe links klippbar	Farbe/Material	Art.-Nr.
3 mm DIN-L	Weiß RAL 9010	5030017409
3 mm DIN-L	Dunkelgrau RAL 7030/7038	5030017412

Unterlegscheibe rechts klippbar	Farbe/Material	Art.-Nr.
3 mm DIN-R	Weiß RAL 9010	5030017403
3 mm DIN-R	Dunkelgrau RAL 7030/7038	5030017406

*RAL-Ton ähnlich. siehe Farbauswahl

Sanitärtrennwände ■ Farbauswahl

RAL-Ton ähnlich*	Standard	Nr.	Farbe
RAL 9010		08	weiß
RAL 7030 / 7038		37	dunkelgrau
Auf Anfrage			
RAL 3003		01	rot
RAL 9005		02	schwarz
RAL 8022		04	dunkelbraun
RAL 6029		05	grün
RAL 1021		07	gelb
RAL 5002		09	blau
RAL 9016		15	verkehrsweiß
RAL 3007		18	dunkelrot
RAL 6012		19	dunkelgrün
RAL 7043		20	verkehrsgrau
RAL 5011 / 5013		21	dunkelblau



ECO Schulte GmbH & Co. KG

Iserlohner Landstraße 89

D-58706 Menden

Telefon +49 2373 9276 - 0

Telefax +49 2373 9276 - 40

info@eco-schulte.de

www.eco-schulte.de

■ SYSTEMTECHNIK FÜR DIE TÜR

